

AVANT[®]

520 / 528

Operator's Manual 2008-



TABLE OF CONTENTS

INTRODUCTION	3
AVANT 500 SERIES WARRANTY	3
EC DECLARATION OF CONFORMITY	4
HOW TO WORK SAFELY	5
DECAL LOCATIONS	6
MAIN PARTS OF THE LOADER	7
TECHNICAL SPECIFICATION	8
TECHNICAL SPECIFICATION, ENGINES	8
DIMENSIONS	8
LOAD DIAGRAM	9
CONTROLS	10
STARTING THE ENGINE	15
STOPPING THE ENGINE	15
DRIVE CONTROL	16
DRIVE PEDALS	16
DRIVING THE MACHINE	17
LOADER CONTROL	17
USING THE AUXILIARY HYDRAULICS	17
COUPLING THE ATTACHMENTS	18
MAINTENANCE SCHEDULE	19
SAFETY INSTRUCTIONS FOR MAINTENANCE	20
MAINTENANCE INSTRUCTIONS	21
REFUELING	23
FUSE BOX	23
FILTER LOCATION	24
FILTER TABLE	24
GREASING POINTS	24
OPERATING INSTRUCTIONS, CAB	25
TROUBLESHOOTING	26
SERVICES MADE	27

INTRODUCTION

AVANT Tecno Oy wants to thank you for purchasing this **AVANT** loader. It is the result of Avant's long experience in design and manufacturing of compact loaders.

We ask you that you read and understand the contents of this manual completely before operating the loader. This will improve your operating and maintenance efficiency, help avoid breakdowns and damage and extend your machine's life.

Contact your local **AVANT** dealer for advice regarding service, parts and any problems relating to the operation of your machine.

AVANT 500 SERIES WARRANTY

This warranty specifically applies to the **AVANT** 500 series loaders only and not to any attachments used with this product.

Any repairs or modifications performed without the prior authorisation of **AVANT** Tecno Oy will cancel this warranty.

During the first year of operation or first 750 hours (whichever is the soonest) **AVANT** Tecno Oy warrants to replace any part or repair any defect which may occur, subject to the terms detailed below:

- 1) The product has received regular maintenance in accordance with schedules given by the manufacturer.
- 2) Any damage caused by operation in a negligent manner or exceeding the approved specifications detailed in this manual is excluded.
- 3) **AVANT** Tecno Oy accepts no responsibility for interruption to working or any other consequential losses resulting from any failure of the product.
- 4) Only **AVANT** Tecno Oy approved replacement or original quality parts shall be used during routine maintenance.
- 5) Any damage caused by the use of incorrect fuel, lubricants, cooling liquid or cleaning solvents is excluded.
- 6) The Avant Warranty excludes any consumable parts (e.g. tyres, batteries, filters, belts etc.) except where it can be clearly shown that these parts were defective on original supply.
- 7) Any damage caused resulting from the use of attachments not approved for use with this product is excluded.
- 8) In the event a fault occurs which is attributable to manufacturing or assembly defect you should arrange to return your **AVANT** to your authorised dealer for repair. Travel and freight cost are excluded.

IDENTIFICATION OF THE LOADER

Write down the following information about your loader, it will help you when ordering parts etc.

1. Model: **AVANT** _____ Purchase date: _____
2. Serial number: _____
3. Engine serial number: _____

The serial number and model of the loader are printed on the manufacturer's plate (decal no. 5, see page 6). Location of engine serial number can be found in the operating manual of the engine.

EC DECLARATION OF CONFORMITY

- 1. Manufacturer: **Avant Tecno Oy**
- 2. Address: **Ylötie 1
FI-33470 YLÖJÄRVI
FINLAND**
- 3. Technical Construction File Location: **Same as Manufacturer**
- 4. Authorized Representative:
- 5. Address:
- 6. **We hereby declare that the machines listed below conform to EC Directives: 98/37/EC (Machinery), 89/336/EEC (EMC) and 2000/14/EC (Noise Emission).**
- 7. Category: **EARTH-MOVING MACHINERY/LOADERS/COMPACT**
- 8. Models: **520, 528**
- 9. Serial Number: _____
- 10. Year of Manufacture: _____
- 11. Net Installed Power: _____ **kW**
- 12. Sound Power Levels – (measured): _____ **dB(A)**; (guaranteed): _____ **dB(A)**
- 13. Directive / Conformity Assessment Procedure / Notified Body:

98/37/EC	Self-certification	-----
89/336/EEC	Self-certification	-----
2000/14/EC	Type-test	MTT Agricultural Engineering Research (VAKOLA) Vakolantie 55, 03400 Vihti, FINLAND

- 14. Name: **Risto Käkelä**
- 15. Position/Title: **Managing Director**
- 16. (Signature)  _____
- 17. Place: **Ylöjärvi, Finland**
- 18. Date: _____

HOW TO WORK SAFELY

An incorrect or careless operation of the loader may be the origin of a serious accident. Before putting the machine into operation, familiarise yourself with the use of the machine and read and understand this Operator's Manual as well as the safety instructions.

THIS SYMBOL INDICATES THE IMPORTANT SAFETY FACTORS.

















Understand the limitations of speed, braking, steering and stability as well as loading capacity of the machine before starting operation. Make sure that every one who operates or works with this equipment is familiar with these safety precautions.

This AVANT loader must only be used for the tasks and with the attachments approved by the manufacturer.

If you have no previous experience of the machine, make sure to do all testing at a safe and open place with no persons in the area of operation.

SAFETY INSTRUCTIONS

-  Never use the loader without instructions. Read and understand all loader signs (decals), and this manual.
-  Start the operation slowly and carefully.
-  Do not wear loose clothing, long uncovered hair or jewelry near machine.
-  When driving be comfortably seated in the driver's seat, keep your feet in their proper place in the footwell and at least one hand on the steering wheel.
-  Operate the control levers and the lever of auxiliary hydraulics only when sitting in the driver's seat.
-  Operate the control levers with ease and without hesitation.
-  When coupling the attachment, make sure that the locking pins lock in positively.
-  Never put any part of the body or let anyone go under the lifted boom.
-  Do not transport persons in the bucket or in any other attachment. The machine is not designed to lift or to transport persons.
-  Keep hands, feet and clothing away from any moving part and/or hydraulic cylinder.
-  Never carry passengers. Keep other bystanders away from the work area.
-  Drive slowly on uneven terrains. Watch out for ditches, manholes and steep gradients.
-  Do not drive on too steep a gradient. Load, unload, and turn on flat level ground.
-  Make sure that the ventilation is sufficient when working indoors or otherwise confined area.



Do not use loader in an atmosphere with explosive dust or gases or where exhaust can contact flammable material, explosion or fire can result.



Do not transport the load with the boom lifted. Always carry bucket or attachment as low as possible, and put the load down whenever you leave the machine.



When lifting or lowering the load, do not operate the boom control lever abruptly. Turn the lever smoothly and with care.



Do not exceed rated operating capacity - follow the load diagrams.



Do not park the machine on a surface with a gradient. Should this be necessary, use the parking brake and preferably turn the machine sideways and put down the bucket. If needed, use chocks behind the wheels.



Before leaving driver's seat:

- Lower the loader boom
- Place attachment flat on ground
- Stop the engine, remove the key
- Engage the parking brake



Never perform any maintenance or repair operation when the engine is running.



Stop and cool the engine before adding fuel.



Never use ether or starting fluid on diesel engines with glow plugs. Use only starting aids as approved by engine manufacturer.



Keep the engine area clean of flammable materials.



Wear eye protection when servicing, and hard hat or other protective equipment as needed.



When connecting a booster battery for "jump" start, always make last connection (negative cable) to engine, never at battery. When removing the "jump" start cable, always remove the negative cable (-) from engine first.



Never charge a frozen battery.



Lead acid batteries produce flammable and explosive gases. Keep arcs, sparks, flames and lighted tobacco away from battery.



Battery acid causes severe burns. In case of acid contact, wash immediately with water for several minutes and get medical attention in case of eye contact.



Use a piece of cardboard to check for hydraulic leaks. Leaking fluids under pressure can enter the skin and cause serious injury. Medical attention is required.



Never modify the loader or add attachments not approved by AVANT Tecno Oy.



Do not smoke during refueling or driving.



If the loader is transported e.g. on a trailer, make sure that the articulation joint is securely locked by fitting the travel lock (painted red) on the left side. Ensure it is removed before commencing driving again.



When turning with the loader, bear in mind that the driver's seat extends beyond the turning radius of the wheels (collision risk).





Read this Operator's Manual carefully, especially if you are unfamiliar with the safe use and operation of the machine.

DECAL LOCATIONS

If any of these decals has been removed or is unreadable it should be replaced without delay.

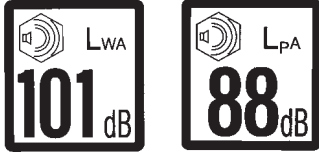
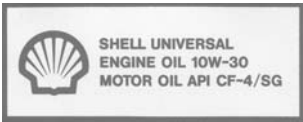
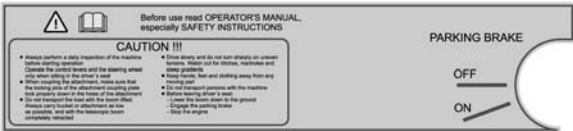
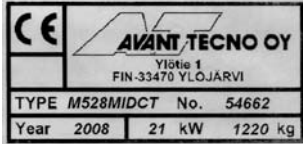

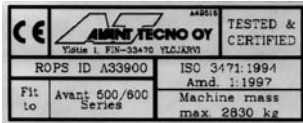
<p>①</p> 	<p>④</p> 
<p>②</p> 	<p>⑤</p> 
<p>③</p> 	<p>⑥</p> 

MAIN PARTS OF THE LOADER

Following picture shows the main parts of the loader:



① **Front frame**

Front frame is the part of the loader in front of the articulation joint. On the front frame are mounted: driver's seat, operating controls, parking brake, hydraulic control valves, hydraulic oil tank, auxiliary hydraulics outlet, front wheels, hydraulic motors and the loader boom with attachment coupling plate.

② **Back frame**

Back frame is the part of the loader behind the articulation joint. On the back frame are mounted: engine with accessories, battery, fuel tank, hydraulic pumps, rear wheels, hydraulic motors.

③ **Articulation joint**

Articulation joint connects the front and back frame. The loader is steered hydraulically by the steering cylinder which is mounted between the front and back frames. Hydraulic hoses and electric wires are conducted through the articulation joint.

④ **Loader boom**

Loader boom is mounted on the front frame with one pivot pin. The attachment coupling plate is mounted on the lower end of the boom. There are two types of booms: standard boom with fixed length and the optional telescopic boom which extends 600 mm hydraulically.

⑤ **Attachment coupling plate**

Attachments are mounted on the attachment coupling plate.

⑥ **Auxiliary hydraulics outlet**

The hydraulic hoses of hydraulically operated attachments are mounted on this outlet with quick couplers. The outlet is double acting: it has two pressure lines and one return line. It is also possible to install an auxiliary hydraulics outlet in the rear of the machine (optional extra).

⑦ **Rear mounting system (optional extra)**

If necessary, attachments can also be mounted on the rear of the machine – on a mounting plate or a rear lift device.

⑧ **ROPS frame**

ROPS frame complies with the standard ISO 3471:1994 with Amendment 1:1997 and Technical Corrigendum 1:2000.

⑨ **FOPS canopy (option)**

FOPS canopy mounts on the ROPS. It meets the ISO 3449:1992 (1365 J) criteria.

TECHNICAL SPECIFICATION

Model	AVANT 520/528
Length	2420/2550 mm
Width (with 23x10.50-12 wheels)	1095 mm
Height (with 23x10.50-12 wheels)	1980 mm
Ground clearance	200 - 235 mm
Weight, starting from	1050/1150 kg
Standard wheels	23x10.50-12"grass/TR
Drive speed	12/10 km/h
Transmission, drive	hydrostatic
Hydraulic oil tank capacity	38 l
Auxiliary hydraulics	AVANT 520: 31 l/min 185 bar AVANT 528: 36 l/min 200 bar
Turning radius inside/outside	995 / 2050 mm
Max. lifting height (with telescopic boom)	
• with 23x10.50-12 wheels	2790 mm
• with 26x12.00-12 wheels	2820 mm
Max. pulling force (depending on model)	700/750 kp
Max. lifting capacity (hydr.)	1350/1500 kg
Max. breakout force / 50 cm	1100/1250 kg

Model	AVANT 520	AVANT 528
Engine make & type	Kubota D 722	Kubota D 1105
Function	4 stroke	4 stroke
Cooling system	water	water
Number of cylinders	3	3
Starter	electric	electric
Bore * stroke	67 * 68 mm	78,0 * 78,4 mm
Displacement	719 cm ³	1124 cm ³
Max. output (ISO Gross)	14 kW (20 hp)	21 kW (28 hp)
Fuel	diesel	diesel
Fuel tank capacity	20 l	30 l
Engine oil type	API CC	API CC
Viscosity	SAE 10W-30	SAE 10W-30
Engine oil capacity	3,8 l	5,1 l
Charging current max.	40 A	40 A

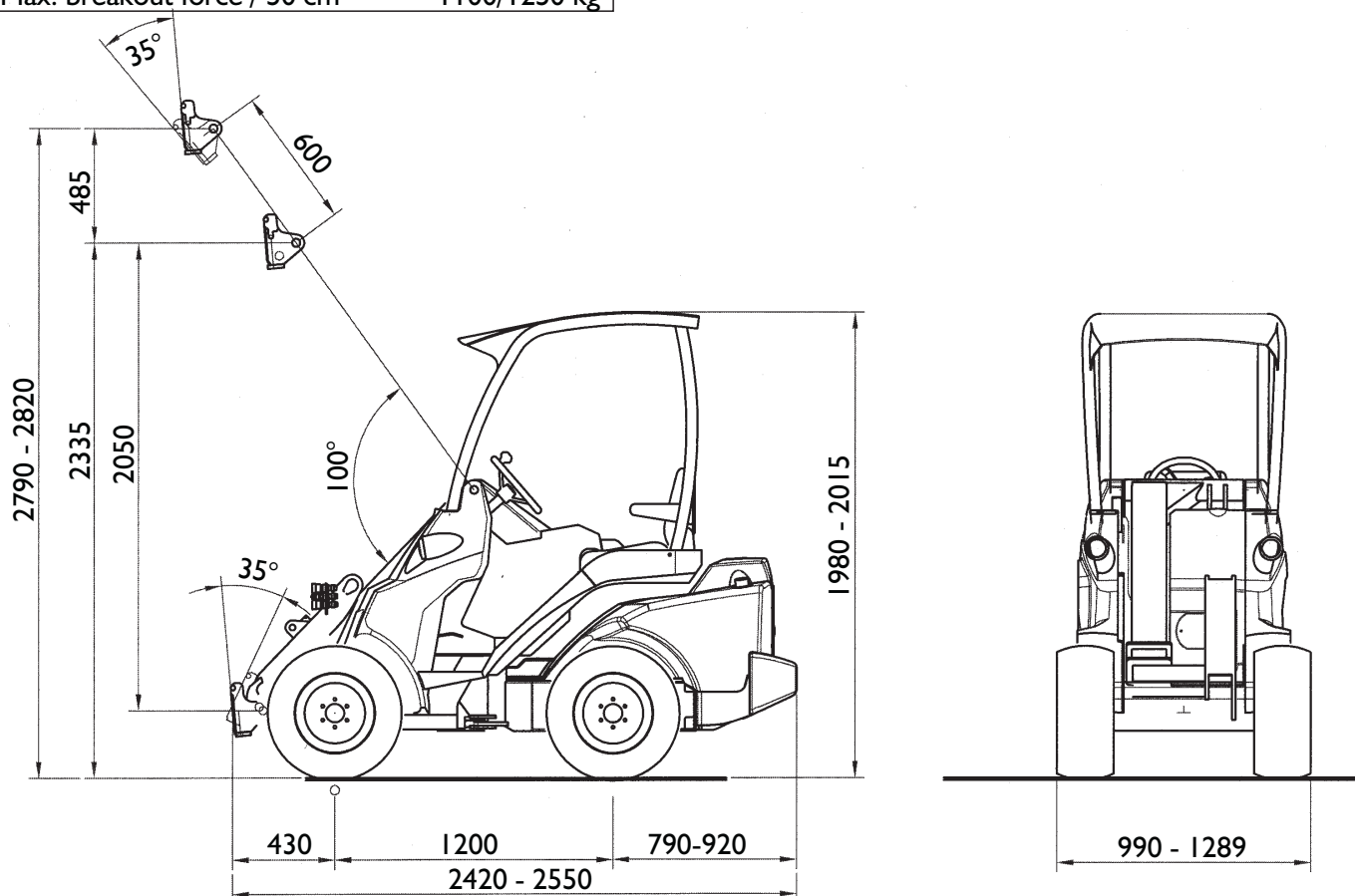

LOAD DIAGRAM

The lifting capacity of the loader is limited by the possibility of tipping around the front axle. The diagram below shows the tipping loads and max. allowed loads in different loading situations on an even level surface with the loader chassis in maximum articulation.

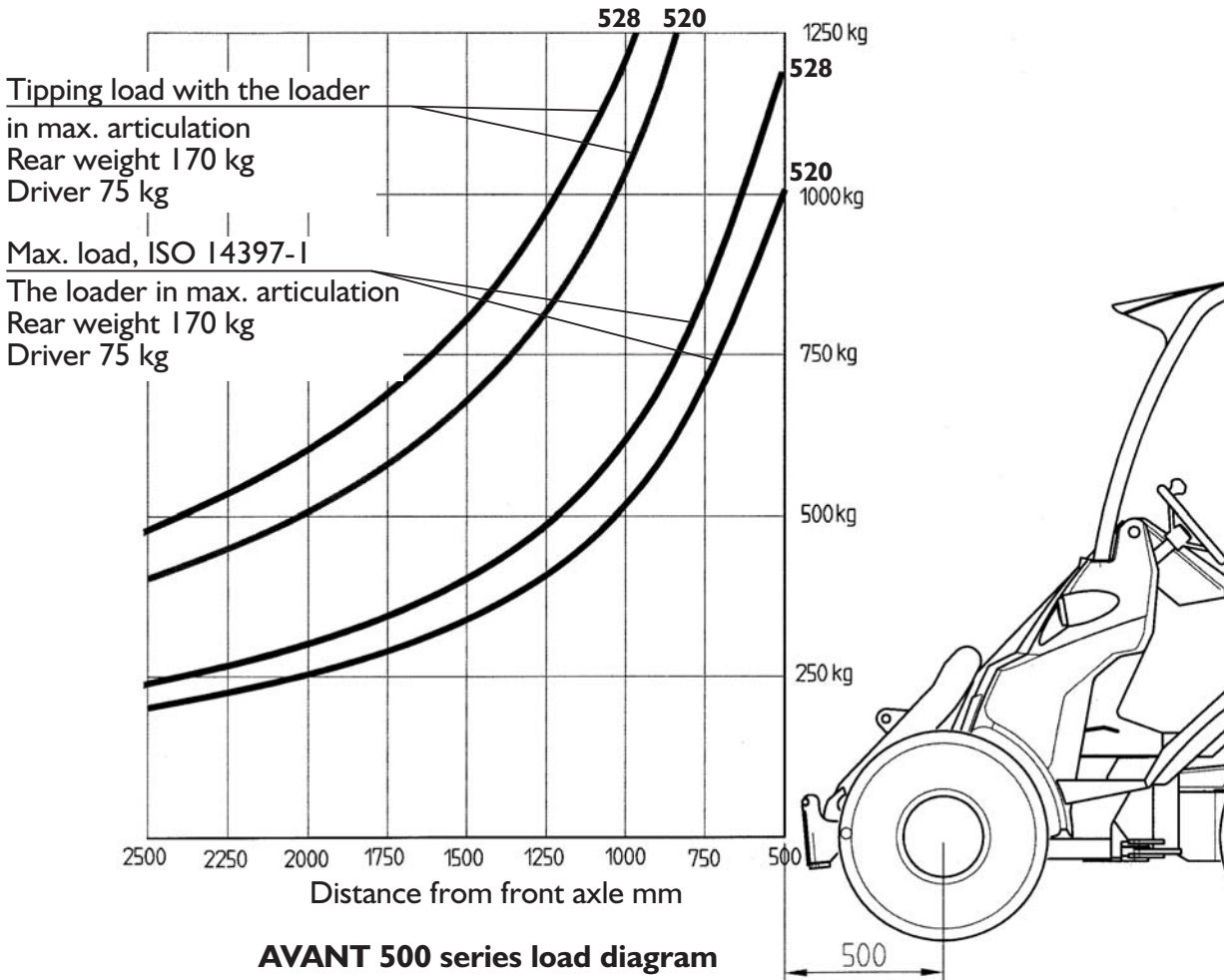

The diagram can be interpreted as follows:

- The diagrams show tipping load and max. load with the load at different distances from the front axle of the loader
- Example: If the center of gravity of the load is 750 mm in front of the front axle, max. load is about 700 kg (520) and 820 kg (528) with a driver weighing 75 kg and with the 170 kg integrated rear weight mounted on the loader.
- Max. load should be reduced when the load is farther away from the attachment coupling plate.
- Tipping load and max. load depend both on the weight of the driver and the eventual extra weights mounted on the loader.
- Please note that the diagrams are based on the machine operating on a level, even and firm supporting ground. Loads should be significantly reduced when operating on gradients and/or on soft ground.
- The loader is equipped with a load sensor system, which gives an audible warning signal and an indicator lights up in the dashboard when tipping load is being approached. See also page 23.



ALWAYS KEEP AND TRANSPORT THE LOAD AS CLOSE TO THE GROUND AS POSSIBLE



NEVER TAKE A HEAVY LOAD ON THE LOADER FROM HIGH LEVEL - E.G. FROM TRUCK, SHELF ETC. - RISK OF TIPPING OVER!



ALWAYS PUT DOWN THE LOAD BEFORE LEAVING THE MACHINE



WHEN LOADING ALWAYS KEEP THE LOADER FRAME AS STRAIGHT AS POSSIBLE

OPERATING CONTROLS

Following picture shows the location of operating controls. The location and function of controls may be slightly different in different models, see following pages.



1. Steering wheel
2. Drive pedal, left: drive backward
3. Drive pedal, right: drive forward
4. Parking brake handle
5. Control lever of boom and bucket
6. Hand throttle lever
7. Auxiliary hydraulics control lever
8. Control lever of telescopic boom (optional extra)
9. 12 V outlet
10. Dashboard

CONTROL OF LOADER BOOM, ATTACHMENTS AND OTHER FUNCTIONS

Most of the functions of the loader are controlled at the control panel on the right side of the operator: Boom and bucket movements, auxiliary hydraulics (attachments), engine revs etc. , depending on loader model. Following pictures show the different functions:

**5. Control lever of boom and bucket**

- Pull backward to lift the boom
- Push forward to lower the boom
- Push left to raise the tip of the bucket (filling)
- Push right to lower the tip of the bucket (emptying)

6. Hand throttle lever

- Push forward to increase engine revs
- Pull backward to reduce engine revs

7. Control lever of auxiliary hydraulics (hydraulically operated attachments)









- Pull backward carefully to test the operating direction of the attachment
- Push forward + turn left to locking position: the attachment operates in reversed direction

8. Control lever of telescopic boom (optional extra)

- Push forward to extend the boom
- Pull backward to retract the boom

DASHBOARD

On the dashboard on the right side of the driver's seat are mounted gauges, indicators and switches which help the operator to control the loader. Dashboard may be slightly different in different models. Following picture shows the different functions:

1. Load sensor indicator 
2. Boom floating indicator 
3. Headlights indicator 
5. Glow plug indicator 
6. Fuel gauge
7. Work light switch
8. Tachometer
9. Hour meter
10. Oil pressure indicator 
11. Charge indicator 
12. Thermometer
13. Ignition switch
14. Signal horn
16. Drive release / anti slip valve switch (optional extra)
17. Boom floating switch (optional extra)
18. Hydraulic cooler fan fuse indicator 
19. Worklight indicator 



CONTROLS IN THE FOOTWELL

Following picture shows the controls located in the footwell

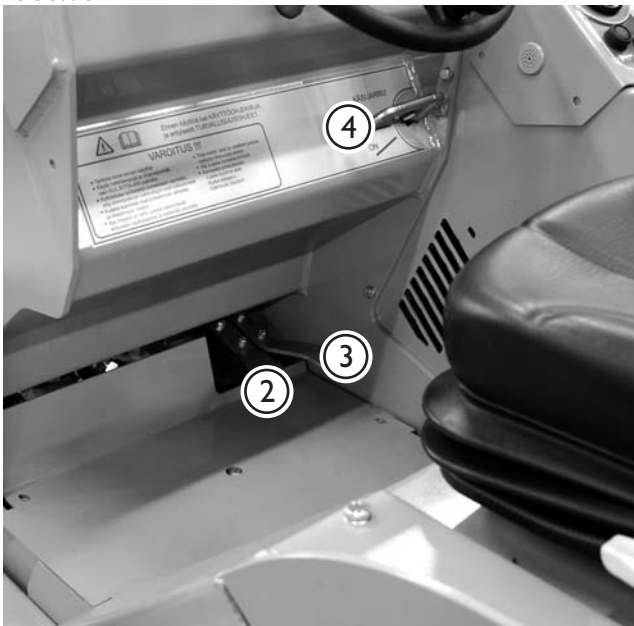

2. Drive pedal, left: drive backward
3. Drive pedal, right: drive forward
4. Parking brake handle
 - locking: pull the handle and turn down into locking position
 - releasing: turn up and let the handle go down

TELESCOPIC BOOM (OPTION)

The optional telescopic boom gives more lifting height and outreach. Length of the telescope is 600 mm and the additional lifting height is 485 mm.

Telescopic boom is operated with the control lever (no. 8 on the control panel, see page 11).



BOOM FLOATING (option)

The floating system releases pressures on the down side of the lift cylinder, allowing the attachment to follow the contours of the terrain.

1. Lower the boom down
2. Switch on the floating with toggle switch no. 17 – FLOAT ON

3. Boom floating indicator on the dashboard (17) lights up



REAR AUXILIARY HYDRAULICS (OPTION)

The loader can be equipped with an auxiliary hydraulics outlet (single or double acting) in the rear of the machine:

1. Quick couplers in the rear

- quick couplers are located on top of the radiator



Rear auxiliary hydraulics are controlled with the auxiliary hydraulics control lever no. 7 on the control panel. If there is a hydraulically operated attachment coupled both in the front and rear auxiliary hydraulics outlet, they both will work when auxiliary hydraulics control lever no. 7 is engaged in order to operate the attachment in the rear.



SUSPENSION SEAT

The suspension seat has the following adjustments:

1. Suspension adjustment

- by turning the lever clockwise suspension gets harder, by turning it counterclockwise the suspension gets softer

2. Angle of the back rest

- the angle of the back rest can be adjusted by turning the knob

3. Seat position

- the distance of the seat from the steering wheel can be adjusted with the lever which is located under the front edge of the seat

Suspension seat is equipped with a seat belt.



BOOM SELF LEVELING (option)

Self leveling system keeps the position of the attachment the same in relation to the ground, regardless of the position of the boom.

Self leveling is hydraulic: there is a leveling cylinder on the left side of the boom which follows the movements of tilt cylinder and keeps the attachment level.



LOCATION OF BATTERY DISCONNECT SWITCH

The loader is equipped with a battery disconnect switch. The switch is located in the rear of the machine, on the right side (see picture). Battery disconnect switch cuts the current between battery and the rest of the electric system.



FRAME LOCK

The frame of the loader can be locked with the red frame lock (see picture). This way the loader frame stays straight during e.g. transportation. There is a place for the frame lock under the seat base (see also page 20).



ENGINE BLOCK HEATER (option)

The loader can be equipped, as an option, with an engine block heater. Engine block heater outlet is on the right side in the rear of the machine.



TRAILER COUPLING (option)

The optional trailer coupling mounts on the rear bumper of the loader. It is equipped with a 50 mm ball coupling.



DRIVE CIRCUIT RELEASE SWITCH (option)

With this switch (no. 16, LOCK) the oil flow between the four hydraulic motors can be diverted.

In normal operation – **LOCK OFF** - hydraulic oil flows in series from motor to motor. With **LOCK ON** selected the hydraulic oil flows in parallel between the hydraulic motors on each side, similar to a differential lock in operation.

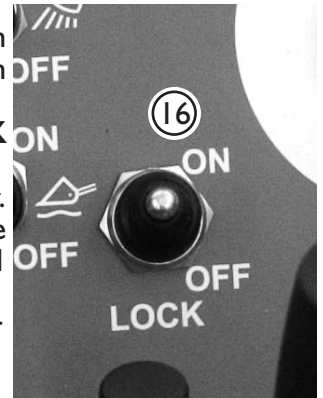

ANTI SLIP VALVE (option)

The valve positively diverts oil flow between right and left side hydraulic motors and improves traction on slippery and uneven surfaces. The function of the anti slip valve is connected to the drive circuit release switch:

LOCK ON: Anti slip valve in operation. Best traction is achieved by using sufficient engine revs and by pressing properly on the drive pedal.

LOCK OFF: Drive circuit released – anti slip valve diverts the oil flow between the front hydraulic motors only, not the rear hydraulic motors.



WHEELS

The loader can be equipped with different types of traction or grass profile wheels. Total machine width with different wheels is:

- 27 x 8.50-15 = 990 mm
- 23 x 8.50-12 = 1050 mm
- 23 x 10.50-12 = 1095 mm
- 26 x 12.00-12 = 1289 mm

WORK LIGHT KIT (option)

The loader can be equipped, as an option, with extra work lights which mount on the ROPS frame.

HEADLIGHT, BEACON, BLINKER & REFLECTOR KIT (option)

This optional equipment enables road traffic registration in certain countries. Requirements vary in different countries, please consult your local AVANT distributor.

STARTING THE ENGINE

Start the engine as follows:



- Turn the battery disconnect switch to ON



- Move the hand throttle lever (6) to approximately ¼ throttle



- Turn the ignition key (13) to the right to glowing position (5) until the yellow glow plug indicator (5) lights up, keep the ignition key in this position until the glow plug indicator goes out
- Turn the ignition key further to the right until the engine starts, then let the key return to ON position



THE ENGINE CANNOT START IF THE AUXILIARY HYDRAULICS CONTROL LEVER (no. 7, see page 11) IS IN LOCKING POSITION

STOPPING THE ENGINE

- Turn the ignition key (13) to the OFF position (to the left)
- Turn the power off with the battery disconnect switch

DRIVE CONTROL



AVANT 500 series loaders are equipped with a hydrostatic drive system, there is a variable displacement hydraulic pump in the drive circuit. The oil flow of this drive pump is steplessly adjusted with the two drive pedals. The drive pedals act in a proportional way to control the drive speed and power available at the drive motors.

This hydrostatic driving system has different operating characteristics to a mechanical drive. To get maximum pushing power push the pedals lightly – for higher travel speed push the pedal harder.

Driving of the machine is **controlled with the drive pedals** as follows:

Select the revs of the engine with the **hand throttle lever** on the control panel. The basic rule is: use lower revs for lighter work and higher revs for hard work.



If you want to **drive forward**, press gently on the **right** drive pedal until the machine starts to move slowly. The desired drive speed is selected with the drive pedal: the more the pedal is pressed the faster you will travel.

When you **wish to stop** gently release the pedal by lifting of your foot, and the machine will slow and stop.

Drive backward is controlled with the **left** drive pedal in the same way as drive forward: the more the pedal is pressed the faster you will travel.

When you have learned how to drive on low speed, increase speed gradually and learn how to drive with higher drive speeds.

FUNCTION OF DRIVE PEDALS



When thinking about the function of the two drive pedals, they should be compared to gears, not to a conventional throttle pedal. The **drive pedal** in a way **shifts on a higher gear** the more the pedal is pressed. Therefore you shouldn't press the pedal more when the engine starts to struggle. Pressing the pedal just causes the engine to stop.

When you want to have a high pulling force:

1. Use high engine revs
2. Select a relatively slow drive speed with the drive pedal. That is: press the pedal only lightly (= select a low gear). This way the full output of the hydraulic system and the engine can be taken out.

STEERING OF THE MACHINE

Steering of the machine happens with the steering wheel. The steering wheel is hydraulically powered. A practical way of steering is to steer with your left hand on the knob of the steering wheel. This way your right hand is free to operate other functions. Familiarise yourself with the special drive features and space needs of this articulated loader on a flat, even and open place.



NEVER TIP OVER THE LOADER. NEVER USE A HIGH DRIVE SPEED WHEN TURNING.

In particular: when the loader boom is up the stability of the machine is much weaker when turning.



WHEN DRIVING, ALWAYS KEEP THE LOADER BOOM AS LOW AS POSSIBLE. Risk of tipping over increases considerably when there is a heavy load on the loader (a heavy attachment or a big load in the bucket) and the boom is up when driving.



ALWAYS REMEMBER – SAFETY FIRST.



TEST ALL THE FUNCTIONS OF THE LOADER AT AN OPEN AND SAFE PLACE.



MAKE SURE THAT THERE ARE NO PERSONS IN THE OPERATING AREA OF THE MACHINE.



REMEMBER THAT, WHEN TURNING, THE DRIVER'S SEAT EXTENDS BEYOND THE TURNING RADIUS OF THE WHEELS.

LOADER CONTROL

The loader boom and bucket are controlled with the multi-function lever sideways (tilt) and back & forward (boom up & down).



- Pull backward to lift the boom
- Push forward to lower the boom
- Push left to raise the tip of the bucket (filling)
- Push right to lower the tip of the bucket (emptying)

USING THE AUXILIARY HYDRAULICS

Auxiliary hydraulics (hydraulically operated attachments) are controlled with the lever no. ⑦ on the control panel. The lever locks in the locking position (on the left) which facilitates operation of the attachments that require constant oil flow (rotary broom, backhoe etc.).



NOTICE! THE ENGINE CANNOT START IF THE AUXILIARY HYDRAULICS CONTROL LEVER IS IN THE LOCKING POSITION.



THE OPERATING DIRECTION OF THE ATTACHMENT DEPENDS ON THE COUPLING OF THE ATTACHMENT HOSES. MAKE SURE THAT THERE ARE NO PERSONS IN THE DANGER AREA WHEN TESTING THE OPERATING DIRECTIONS. CHANGE THE COUPLING OF THE HOSES IF NECESSARY.

HAND THROTTLE



When driving, the revolution speed of the engine can be adjusted with the hand throttle lever, if necessary. Do not turn the machine with a high travel speed.

COUPLING THE ATTACHMENTS

Coupling of the attachments into the attachment coupling plate happens as follows:



Stage 1:

- Lift up the two locking pins on both sides of the attachment coupling plate and turn them backward so that they remain in the up position
- Make sure that the pins remain in the up position, otherwise you cannot couple the attachment properly!



Stage 2:

- Turn the attachment coupling plate with the tilt movement so that the upper edge of the plate leans forward.
- Drive the loader into the attachment



Stage 3:

- Lift the boom a little so that the attachment lifts off of the ground
- Pull the boom control lever to the left so that the lower edge of the attachment coupling plate turns into the attachment



Stage 4:

- Pull the boom control lever more to the left so that attachment coupling plate turns more and the brackets on the boom push the pins down in the holes of the attachment.
- **CAUTION! Make sure that the pins lock properly down in the holes of the attachment.**

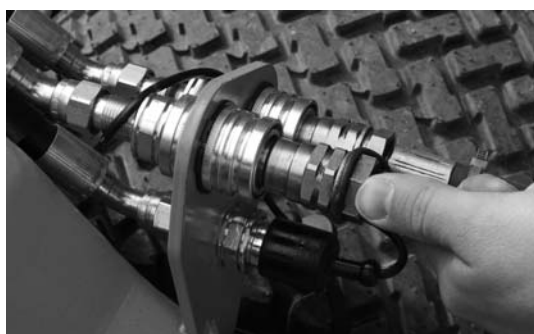

Stage 5:

- If the attachment is equipped with hydraulic hoses, make sure to connect the hoses in the quick couplings on the loader
- Engine must be stopped when connecting the hoses. Before connecting the hoses move the auxiliary hydraulics control lever in both directions a couple of times in order to release eventual back pressure.
- **NOTICE! When fitting an attachment, make sure that the hydraulic hoses are not overstretched and are not in a position where they can be trapped during the operation of the machine and attachment.**
- Additional information about the coupling is provided in the instruction manual of the attachment.

MAINTENANCE SCHEDULE

Following table shows the maintenance and service points and intervals. There are more detailed instructions about each service operation, in numerical order, on the following pages.

LOADER	Every day	Every week	After 50h	Every 100h	Every 200 h/year	Every 400h	Every 800h	Every year
1. Clean the machine	■							
2. Check tyre pressure		●						
3. Check battery electrolyte level		●						
4. Check hydraulic oil level		●						
5. Change hydraulic oil filters			●		●			
6. Change hydraulic oil			●		●			
7. Check tightness of bolts, nuts and hydraulic fittings			●					
8. Check pressure of hydraulic system			■					●
9. Adjust pressure of hydraulic system			■					■
10. Check slide pads 1 and 2 on the boom		●						
11. Adjust or change slide pads 1 and 2			■					
12. Check slide pads 3, 4, 5, 6, 7 and 8						●		
13. Change slide pads 3, 4, 5, 6, 7 and 8						■		
14. Calibrate load sensor					●			
15. Grease the machine	■	●						
ENGINE*)								
16. Check engine oil level	●							
17. Change engine oil			●		●			●
18. Clean air filter		●			●			
19. Clean fuel filter and sediment cup					●			●
20. Check condition and tightness of alternator belt					●			●
21. Check water hoses and hose clamps					●			
22. Change engine oil filter					●			●
23. Change fuel filter						●		
24. Clean fuel tank								●
25. Clean radiator cells		■						
26. Change coolant								●
27. Change air cleaner element				■				●
28. Check and adjust valve clearances							●	
29. Check opening pressure of nozzles							●	

● Maintenance operation

■ When necessary

*) More specific engine maintenance instructions can be found in the owner's manual of the engine, supplied with the loader.

SAFETY INSTRUCTIONS FOR MAINTENANCE



ALWAYS REMEMBER SAFETY DURING MAINTENANCE
DO NOT PERFORM ANY SERVICE OPERATION WHEN THE ENGINE IS RUNNING
USE THE SERVICE SUPPORT ON THE BOOM CYLINDER
DO NOT GO UNDER UNSUPPORTED BOOM
DO NOT SMOKE DURING SERVICE OPERATIONS
BEWARE POSSIBLE HIGH PRESSURE IN HYDRAULIC CIRCUITS

MOUNTING OF THE SERVICE SUPPORT



Make sure that the boom stays up during maintenance operations by putting the service support on the lift cylinder piston rod.

The red service support – and also the frame lock – are located under the seat base, fastened with a bolt (see picture)



Make sure to secure the service support by locking it on the piston rod by the bolt

SAFETY INSTRUCTIONS WHEN HANDLING THE BATTERY



- **BATTERY CONTAINS CORROSIVE SULFURIC ACID.**
- **AVOID CONTACT WITH SKIN OR CLOTHES. IF ELECTROLYTE GETS ON YOUR SKIN OR CLOTHES, FLUSH WITH A LOT OF WATER.**
- **IN CASE OF CONTACT WITH EYES, FLUSH WITH A LOT OF WATER FOR AT LEAST 15 MINUTES AND CONSULT A DOCTOR IMMEDIATELY.**
- **WHEN CHARGING THE BATTERY GIVES OFF POTENTIALLY EXPLOSIVE GASES – DO NOT SMOKE WHEN HANDLING THE BATTERY.**
- **IN ORDER TO AVOID SPARK EMISSIONS ALWAYS DISCONNECT THE NEGATIVE (-) CABLE FIRST AND CONNECT IT LAST.**
- **BEFORE CONNECTING THE BATTERY CABLES MAKE SURE THAT THE POLARITY IS CORRECT: FAULTY CONNECTION WILL SERIOUSLY DAMAGE THE ELECTRIC SYSTEM OF THE ENGINE.**

8. CHECK PRESSURE OF HYDRAULIC SYSTEM

Pressure checking points for different functions are as follows:

Auxiliary hydraulics: Pressure is checked by mounting the manometer in the female auxiliary hydraulics quick coupling, with full revs and by turning the aux. hydraulics control lever. Pressure setting should be 185 bar for 520 and 205 bar for 528.



Drive pressure: In order to check the pressure in the drive circuit one needs to mount a pressure gauge in the pressure line in each and every case, if pressure seems to be clearly wrong. There are two pressure relief cartridges (one for drive forward, one for drive backward) which have fixed pressure setting: 250 bar for 520 and 300 bar for 528. **It is recommended pressures should only be checked by a competent and experienced technician. Call your AVANT dealer if you need assistance.**

9. ADJUST PRESSURE OF HYDR. SYSTEM

If the pressure of hydraulic system does not seem to be correct or pressure check indicates that the pressure is wrong, it can be adjusted. The adjustment screw is protected with nut and there is a seal ring under the nut. When taking off the nut make sure that the seal ring doesn't get lost. See picture below for pressure adjustment point.

Auxiliary hydraulics: Pressure is adjusted from the pressure relief valve at the main control valve. Pressure adjustment screw is on the right, on top of the valve segment (see picture). Adjust by turning the hexagonal head screw which is under the cap. Adjust by turning the screw with a screwdriver. Pressure setting should be 185 bar for 520 and 205 bar for 528.

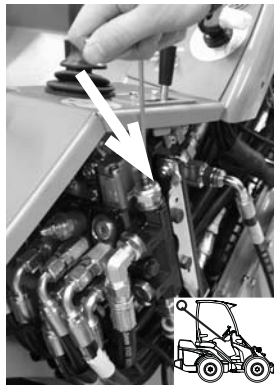

Drive pressure: Can not be adjusted. If the pressures are clearly wrong one must change the pressure relief cartridges which have fixed pressure setting: 250 bar for 520 and 300 bar for 528.



NEVER EXCEED THE RECOMMENDED HYDRAULIC PRESSURE SETTINGS. EXCESSIVE HYDRAULIC PRESSURE WILL DAMAGE THE HYDRAULIC PUMPS, CYLINDERS, AND HYDRAULIC MOTORS.



WARRANTY DOES NOT COVER DAMAGES CAUSED BY EXCESSIVE HYDRAULIC PRESSURE.

10-13 ADJUST AND CHANGE THE SLIDE PADS ON TELESCOPIC BOOM

The telescopic boom is equipped with slide pads. At the lower end of the outer boom there are slide pads made of nylon (nos. 1 and 2) and bronze (nos. 3 and 4). In addition, there are four slide pads (nos. 5, 6, 7 and 8), made of aluminium-bronze alloy, at the upper end of the inner boom. All slide pads can be replaced, and the nylon slide pads on the outer boom can also be adjusted. This way the natural wear of the slide pads, caused by the use of the telescopic boom, can be compensated.

Slide pads nos. 1 and 2 can be adjusted by mounting thin adjustment sheets between the boom and the slide pad. Extend the telescope almost completely and press the boom against the ground, it is the easiest way to mount the adjustment sheet under slide pad no. 2. However, if there is substantial wear in the slide pads it is advisable to replace both pad no. 1 and 2.

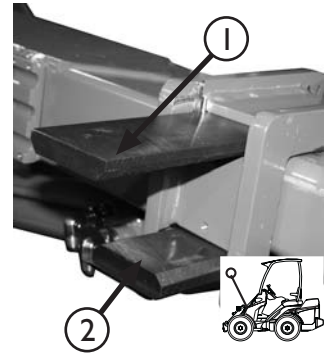

Slide pads nos. 3 and 4 on the side of the outer boom and **slide pads nos. 5, 6, 7 and 8** at the upper end of the inner boom last very long in normal use. Slide pads 3, 4, 5, 6, 7 and 8 should be checked every 400 operating hours. Checking happens by taking the inner boom completely out of the outer boom. If the pads have worn so much that they are level with the boom, change the pads.

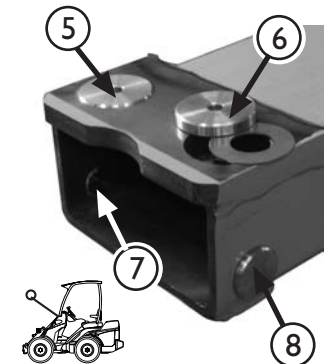
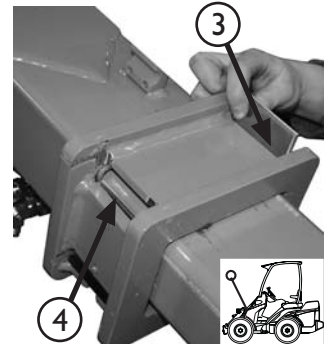

Part nos. for the slide pads are:

Slide pad 1 and 2: A48339
 Slide pad 3 and 4: A48340
 Slide pad 5 and 6: A47922
 Slide pad 7 and 8: A48343
 Washer under slide pads 5 and 6: A47941
 Adjustment sheet, short: A48013
 Adjustment sheet, long: A48014

14. FUNCTION AND CALIBRATION OF LOAD SENSOR

The loader is equipped with a load sensor system. It gives an audible warning signal and at the same time an indicator lights  in the dashboard when tipping load is being approached. When the system gives a warning signal the load that is being lifted is too heavy in relation with the lift capacity of the loader. In this case one has to either put more counterweights on the loader or relieve the load that is being lifted.



WHEN THE LOAD SENSOR STARTS TO WARN OF EXCESSIVE LOAD: AVOID ABRUPT MOVEMENTS, STOP LIFTING OF THE BOOM, RETRACT TELESCOPIC BOOM AND LOWER THE BOOM SLOWLY.



WHEN THE LOAD SENSOR IS WARNING DO NOT STEER THE MACHINE BEFORE THE BOOM IS LOWERED DOWN TO GROUND LEVEL



NEVER EXTEND THE TELESCOPE WHEN THE LOAD SENSOR IS WARNING.

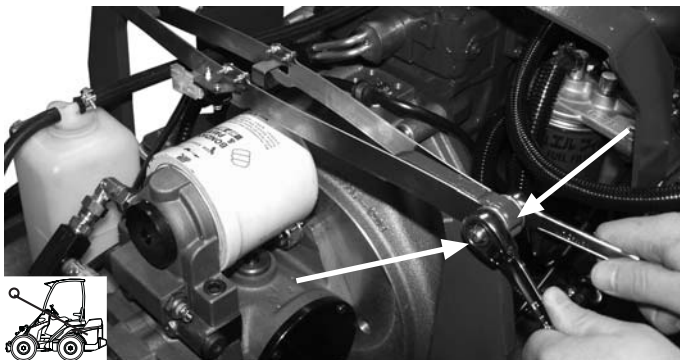

The load sensor must be calibrated in case one adds or removes more than two AVANT rear weights (+/- 65 kg) on the machine. Calibrating happens as follows:

1. Mount the amount of rear weights with which you are going to use the loader.
2. Remove the engine cover plate and the lower left side rear cover plate.
3. Lift something so heavy with the loader that the rear wheels lift off the ground.
4. Open the screw pointed by the arrows (see picture) with two 13 mm keys. As the two steel strips come in contact, tighten the screw.
5. Lower the rear wheels back to the ground and mount the cover plates.
6. Check function of the load sensor.

ATTENTION! The rear of the loader can not be lifted with a jack in order to do the calibration. The rear wheels must be lifted by using the loader boom in order that the adjustment can be done correctly.

15. GREASING OF THE MACHINE

Greasing of pivot points is very important in order to avoid wear. Most of the greasing points are on the loader boom. There are 16 grease nipples altogether on a machine with standard boom and 18 grease nipples on a machine with telescopic boom. The pictures on page 24 show the location of grease nipples.

16.-29. SERVICE, ENGINE

AVANT 500 series loaders are equipped with a Kubota diesel engine (see technical specification sheet for the engine type of each model). Service and maintenance instructions for the engines can be found in the Kubota Operator's Manual supplied with the loader.

REFUELING

Check fuel level and fill the tank if necessary. Use diesel fuel only, in accordance with the instructions in the Kubota engine Operator's Manual. Use of other fuels is not allowed, because their quality and properties cannot be guaranteed. Make sure not to let the fuel tank get empty. Should this happen, refuel and restart - the engine is fitted with automatic fuel bleeding.



DO NOT SPILL FUEL WHEN REFUELING. SHOULD THIS HAPPEN, WIPE THE FUEL AWAY IMMEDIATELY IN ORDER TO AVOID RISK OF FIRE.



ALWAYS STOP THE ENGINE BEFORE REFUELING.



KEEP THE ENGINE AWAY FROM OPEN FIRE. DO NOT SMOKE DURING REFUELING.

FUSE BOX

The fuse box is located on the right side of the loader boom. Fuses can be checked by first lifting the boom so that the fuse box can easily be reached. The list on the right shows the location and function of each fuse in the fuse box.

If the engine does not run and the boom cannot be lifted, the fuses can be checked after removing the right side cover plate.

25A	Oil cooler
10A	Indicator lights Signal horn
20A	12V outlet Work lights Extra work lights
20A	Road traffic lights Boom floating
25A	Cab
15A	Seat heater Joystick



REMEMBER TO USE THE SERVICE SUPPORT

FILTERS

Following pictures and tables show the location and part numbers for the filters.

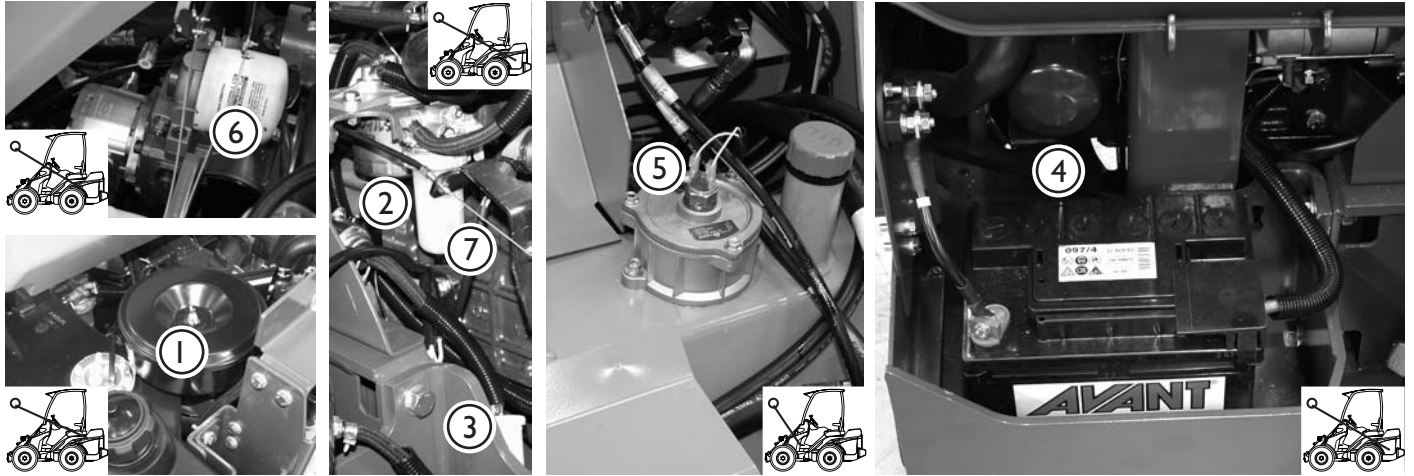

AVANT 520/528 filters

1. Air filter
2. Fuel filter
3. Fuel filter, pre filter
4. Engine oil filter
5. Hydraulic oil filter, return
6. Hydraulic oil filter, pressure
7. Water separator

Part numbers, filters

520 Filter kit A49572 includes:

- 65106 Air filter
- 64626 Fuel filter
- 64657 Fuel filter, pre filter
- 64207 Engine oil filter
- 74093 Hydraulic oil filter, return
- 64807 Hydraulic oil filter, pressure

528 Filter kit A48036 includes:

- 64956 Air filter
- 64626 Fuel filter
- 64657 Fuel filter, pre filter
- 64627 Engine oil filter
- 74093 Hydraulic oil filter, return
- 64807 Hydraulic oil filter, pressure

There is also a water separator with a filter in the fuel system. This water separator filter is not included in the filter kit and it needs not to be changed, unless it breaks. Part no. for the water separator filter is 64963.

GREASING POINTS

Following pictures show the location of greasing points.

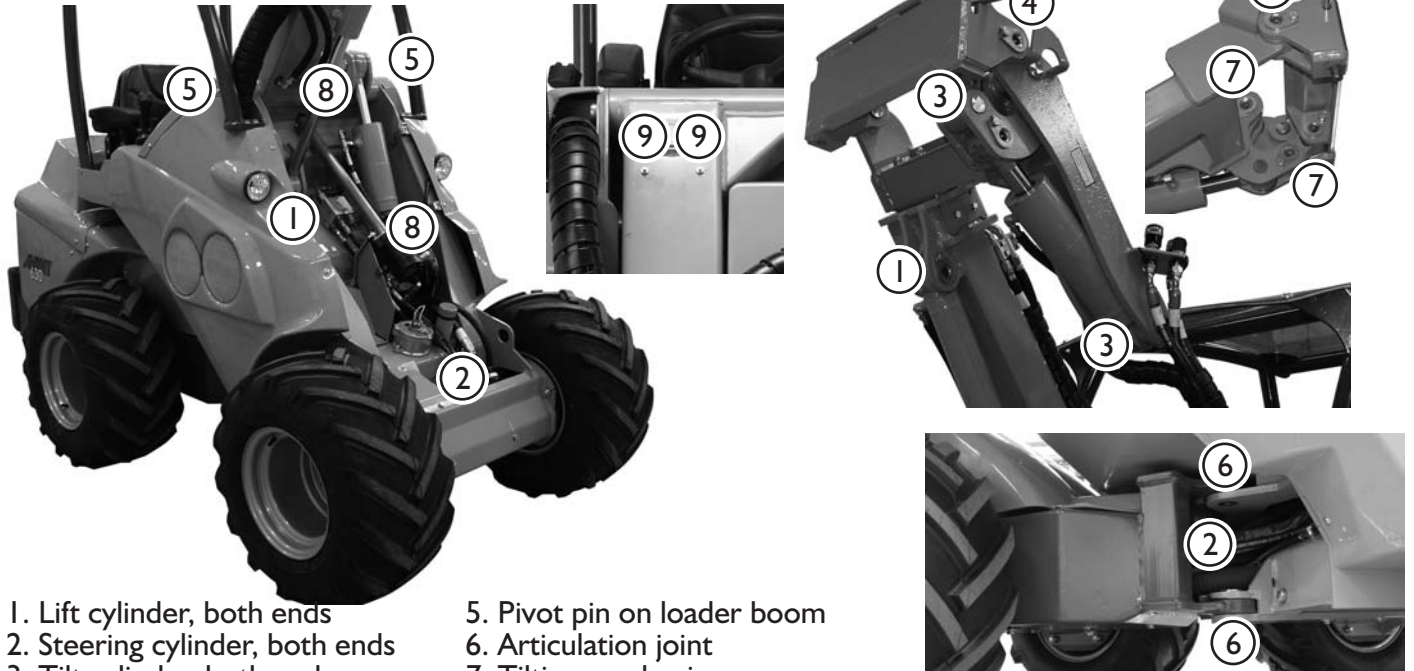

1. Lift cylinder, both ends
2. Steering cylinder, both ends
3. Tilt cylinder, both ends
4. Pivot pins on attachment coupling plate/boom

5. Pivot pin on loader boom
6. Articulation joint
7. Tilting mechanism
8. Leveling cylinder, both ends
9. Telescopic boom, grease with boom completely retracted

Check the tightness of the pivot pin locking screws, if loose tighten and use thread locker.

CAB



AVANT 500 series can be equipped with a cab. Here the operating instructions for the cab:

All the other switches are located at the control panel on the right side except the thermostat of the heater which is located at the front panel on the left.

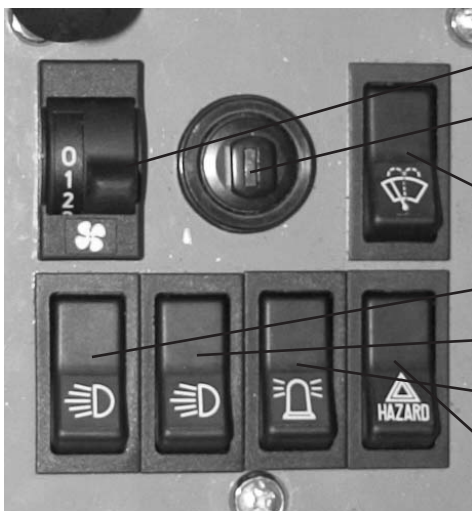
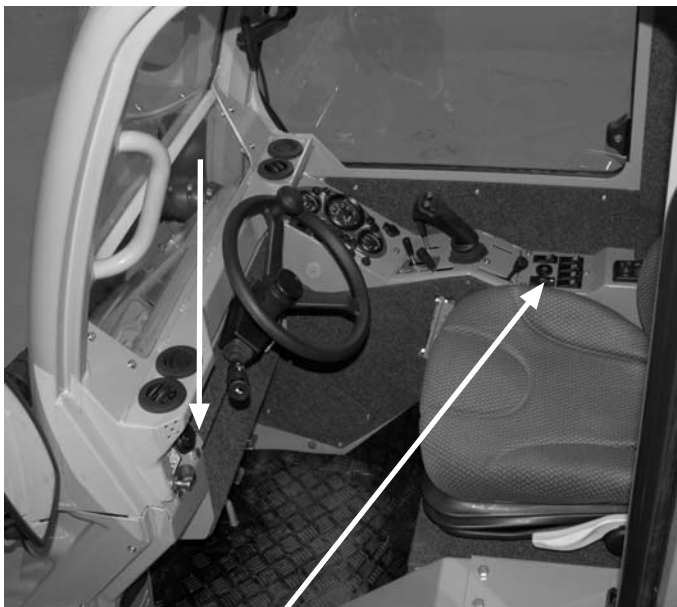

- Fan
- Ignition switch
- Windscreen wiper and washer
- Work light, front
- Work light, rear
- Beacon
- Emergency blinker

The windscreen washer tank is located under the doorstep left, and the filler hole is under the carpet.

The fuse (25A) for electrical equipment of the cab is located in the fuse box of the loader, under the front cover plate (see page 23).

Heater

The cab is equipped with a warm water heater which works like a central heating system, using the coolant of the engine.

Cab temperature can be adjusted with the thermostat on the front panel left.

Air flow can be directed with the nozzles on the front panel and in the footwell.

Heating efficiency and air flow can be adjusted with the fan.

The cab is also equipped with an air circulation system: There is a ventilation hatch under the nozzle in the footwell. The hatch is adjusted with two finger screws. As soon as the hatch is opened the heating system starts to take warm air from the cab and circulates it through the nozzles back in the cab. This way the cab warms up quicker in cold weather.

ATTENTION! Switch off the air circulation as soon as the temperature in the cab is sufficient, otherwise the cab keeps warming up and moisture starts to condense on the windows.

The right side window of the cab can be opened in order to improve circulation of air.



ATTENTION!
NEVER DRIVE WITH THE CAB DOOR OPEN. DO NOT TURN THE STEERING WHEEL WHEN THE CAB DOOR IS OPEN.

Safety

Familiarise yourself with the special drive features and space needs of this articulated loader, equipped with cab, on a flat, even and open place. Remember that, when turning, the cab extends beyond the turning radius of the wheels. This should be taken into consideration especially when driving in confined spaces, in order that the rear of the cab will not get damaged.

ATTENTION! It is not allowed to drive and/or to turn with the loader with the cab door open, otherwise the glass door of the cab can break.

The cab is a certified ROPS/FOPS structure and complies with the ROPS standards ISO 3471:1994 with Amendment 1:1997 and Technical Corrigendum 1:2000; and EN 13510:2000; and FOPS standard ISO 3449:2005 (I365 J).

TROUBLESHOOTING

Problem	Cause	Remedy
<p>Hydraulic attachment does not work when the auxiliary hydraulics control lever is moved.</p>	<p>Attachment hoses are not coupled or they are coupled wrongly in the quick couplers.</p> <p>Faulty or damaged quick couplers (will restrict or stop oil flow)</p>	<p>Make sure that the hoses are properly connected into the quick couplers, change the place of the hoses if necessary. Auxiliary hydraulics have double acting pressure couplers (female) and a return line (male coupler) Operating direction of the attachment depends on how the hoses are connected in the quick couplers.</p> <p>Replace quick couplers.</p>
<p>Engine does not start.</p>	<p>No fuel.</p> <p>Auxiliary hydraulics control lever is in locking position.</p> <p>Blown fuse no. 3 (fuses in the fuse box are numbered).</p> <p>Battery empty or damaged.</p> <p>If the starter motor works but there comes no smoke from the exhaust when one tries to start, the engine is not getting fuel.</p>	<p>Fill the tank and start the engine. Diesel engines have automatic fuel bleeding – just glow and restart.</p> <p>Turn the lever in center (neutral) position.</p> <p>Change the fuse.</p> <p>Jump start with another battery, then charge the battery, or replace if damaged.</p> <p>Make sure that the fuel hoses and fuel filter are clean and not frozen. Clean if necessary.</p>
<p>Attachment hoses will not go into the quick couplers of the machine.</p>	<p>There is back pressure in the auxiliary hydraulics line.</p>	<p>Release the pressure by moving the auxiliary hydraulics control lever in both directions.</p>
<p>The machine moves after parking brake has been engaged.</p>	<p>The pins of the parking brake mechanism have not locked properly in the wheels.</p>	<p>Drive slowly forward or backward in order to lock the parking brake. When releasing the parking brake do this in opposite order.</p>

SERVICES MADE

Date	Operating hours	Remarks
1. _____	_____	_____ _____
2. _____	_____	_____ _____
3. _____	_____	_____ _____
4. _____	_____	_____ _____
5. _____	_____	_____ _____
6. _____	_____	_____ _____
7. _____	_____	_____ _____
8. _____	_____	_____ _____
9. _____	_____	_____ _____
10. _____	_____	_____ _____



AVANT[®]

AVANT TECNO OY

www.avanttecno.com

e-mail: sales@avanttecno.com

Ylotie 1
FIN-33470 YLOJARVI
FINLAND

Tel. +358 3 347 8800

Fax +358 3 348 5511

AVANT has a policy of continuing improvement, and retains the right to change specifications without notice.